

出荷明細書

現場名 四日市別山ニュータウン2号公園フォーリー2工事									
NO	名称	樹種	B 幅	H 成	L 長さ	本数	m <sup>2</sup> /本	m <sup>3</sup> 数	備考
1	フォーリー2						0	0	
2	梁	米ひば・湾曲	90	150	4,400	2	0.06	0.12	内R=3600
3	つなぎ梁	"	90	130	3,800	2	0.045	0.09	内R=3600
4	垂木	"	60	120	5,000	12	0.036	0.432	内R=3750
5							0	0	
6	柱	米ひば・通直	180	180	3,400	2	0.111	0.222	
7	"	"	180	180	2,900	2	0.094	0.188	
8	床梁	"	120	300	2,900	4	0.105	0.42	
9	方杖	"	90	90	1,800	8	0.015	0.12	
10	"	"	90	90	700	4	0.006	0.024	
11	手すり	"	120	100	2,900	3	0.035	0.105	
12	"	"	120	100	1,000	2	0.012	0.024	
13	階段手すり	"	100	100	2,900	2	0.029	0.058	
14	手すり子柱	"	90	120	900	3	0.01	0.03	
15	階段支柱	"	120	120	1,250	4	0.018	0.072	
16	階段桁	"	100	300	3,000	2	0.09	0.18	
17	手すり格子	"	60	60	800	18	0.003	0.054	
18	筋交い	"	60	90	1,200	2	0.007	0.014	
19	"	"	60	90	1,600	6	0.009	0.054	
20	踏板	"	40	584	900	5	0.022	0.11	
21									
22	床根太	米杉 210	38	230	3,000	5	0.027	0.135	
23	床板	米杉 206	38	140	3,100	25	0.017	0.425	
24							0	0	
25	パーゴラ・湾曲橋						0	0	
26	梁	米ひば・湾曲	90	150	4,500	2	0.061	0.122	内R=3600
27	階段桁	"	100	300	4,800	2	0.144	0.288	内R=7400
28	階段手すり	"	120	100	4,600	2	0.056	0.112	内R=8298
29									
30	つなぎ梁	米ひば・通直	90	130	3,000	2	0.036	0.072	
31	垂木	"	60	120	3,800	18	0.028	0.504	
32	柱	"	180	180	3,200	2	0.104	0.208	
33	"	"	180	180	2,700	2	0.088	0.176	
34	床梁	"	120	300	3,000	4	0.108	0.432	
35	方杖	"	90	90	1,700	8	0.014	0.112	
36	"	"	90	90	700	4	0.006	0.024	
37	手すり	"	120	100	3,000	3	0.036	0.108	
38	"	"	120	100	1,000	2	0.012	0.024	
39	手すり子柱	"	90	120	1,000	4	0.011	0.044	
40	手すり格子	"	60	60	750	28	0.003	0.084	
41	階段支柱	"	120	120	1,300	4	0.019	0.076	
42	踏板	"	40	310	900	9	0.012	0.108	
43	"	"	40	335	900	5	0.013	0.065	
44	筋交い	"	60	90	1,100	1	0.006	0.006	
45	"	"	60	90	1,300	1	0.008	0.008	
46	"	"	60	90	1,700	5	0.01	0.05	
47	スロープ桁	"	100	150	2,100	2	0.032	0.064	
48									
49	床根太	米杉 210	38	230	3,000	5	0.027	0.135	
50	床板	米杉 206	38	140	3,100	25	0.017	0.425	
	小計					253		6.124	

出荷明細書

現場名 四日市別山ニュータウン2号公園フォーリー2工事									
NO	名称	樹種	B 幅	H 成	L 長さ	本数	m <sup>2</sup> /本	m <sup>2</sup> 数	備考
1	ウェーブパーゴラ						0	0	
2	梁 (前)	米ひば・湾曲	90	150	3,900	2	0.053	0.106	内R=3600
3		"	90	150	3,300	1	0.045	0.045	内R=3450
4	梁 (後)	"	90	150	3,300	1	0.045	0.045	内R=3600
5		"	90	150	3,900	2	0.053	0.106	"
6		"	90	150	3,300	2	0.045	0.09	内R=3450
7									
8	つなぎ梁	米ひば・通直	90	130	3,000	4	0.036	0.144	
9	垂木	"	60	120	3,900	40	0.029	1.16	
10	柱	"	180	180	2,800	4	0.091	0.364	
11	"	"	180	180	2,200	6	0.072	0.432	
12	"	"	180	180	2,400	1	0.078	0.078	
13	床梁	"	120	300	3,000	10	0.108	1.08	
14		"	120	300	2,200	2	0.08	0.16	
15		"	120	180	1,700	2	0.037	0.074	
16		"	120	180	800	4	0.018	0.072	
17	方杖	"	90	90	1,800	10	0.015	0.15	
18	"	"	90	90	1,600	8	0.013	0.104	
19	"	"	90	90	700	10	0.006	0.06	
20	手すり	"	120	100	3,000	5	0.036	0.18	
21	"	"	120	100	2,200	1	0.027	0.027	
22	"	"	120	100	1,500	2	0.018	0.036	
23	"	"	120	100	500	2	0.006	0.012	
24	手すり子柱	"	90	120	1,000	5	0.011	0.055	
25	階段支柱	"	120	120	1,200	4	0.018	0.072	
26	地覆木	"	100	100	1,000	4	0.01	0.04	
27	筋交い	"	60	90	1,300	2	0.008	0.016	
28		"	60	90	1,600	12	0.009	0.108	
29									
30	床根太	米杉 210	38	230	3,000	18	0.027	0.486	
31	床板	米杉 206	38	140	3,100	88	0.017	1.496	
32									
33									
34									
35									
36									
37									
38									
39									
40									
41									
42									
43									
44									
45									
46									
47									
48									
49									
50									
	小計					252		6.798	
	合計					505		12.922	

屋根梁 (米ヒバ・湾曲集成材)

つなぎ梁 (米ヒバ・湾曲・通直集成材)

床梁 (米ヒバ・通直集成材)

床梁 (米ヒバ・通直集成材)

柱 (米ヒバ・通直集成材)

階段柱 (米ヒバ・通直集成材)

加圧桁 (米ヒバ・通直集成材)

内径 各種

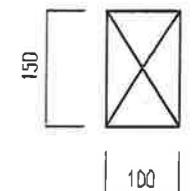
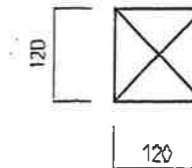
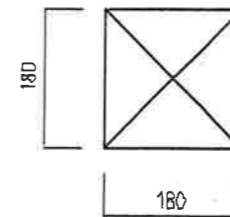
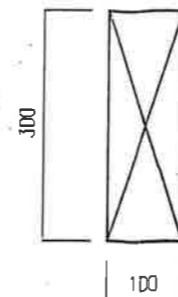
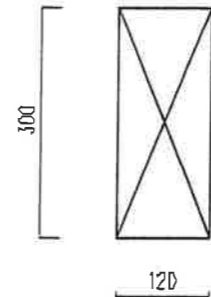
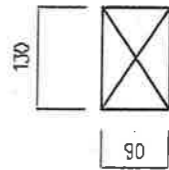
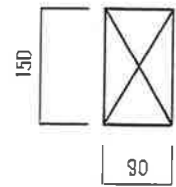

階段手すり (米ヒバ・通直集成材)

手すり (米ヒバ・湾曲・通直集成材)

手すり格子 (米ヒバ・通直集成材)

手すり小柱 (米ヒバ・通直集成材)

垂木 (米ヒバ・湾曲・通直集成材)

方杖 (米ヒバ・通直集成材)

筋交い (米ヒバ・通直集成材)

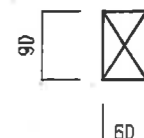
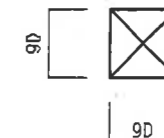
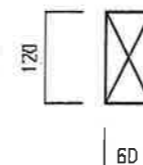
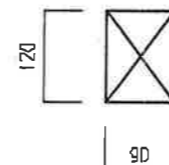
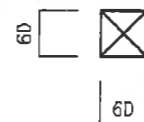
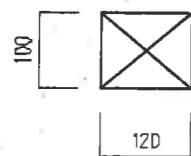
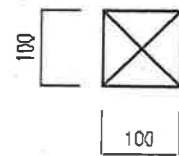

踏板 (米ヒバ・通直集成材)

踏板 (米ヒバ・通直集成材)

ササフ桁 (米ヒバ・湾曲集成材)

床根太 (米杉・210)

床板 (米杉・206)

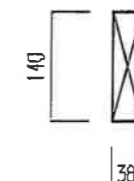
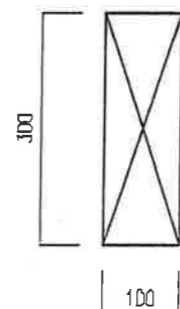
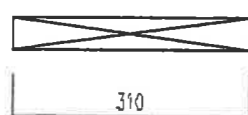

名称 四日市別山ニヤカク2号公園ファミリー-2工事

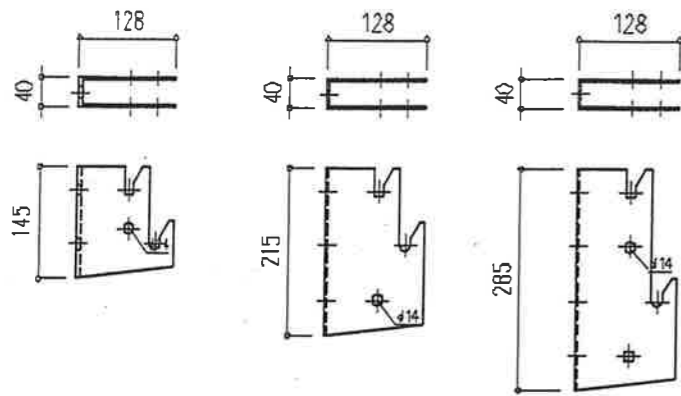

梁受金物

梁受金物

梁受金物

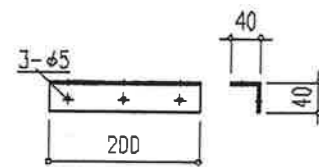

段板受けアングル

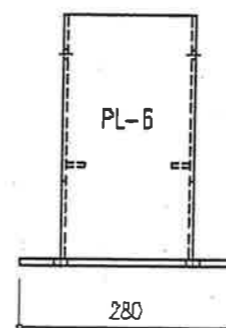
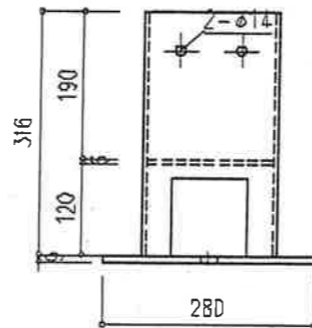
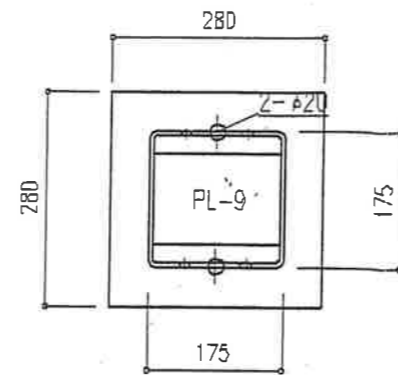

ベース金物

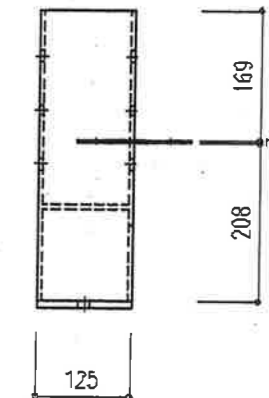
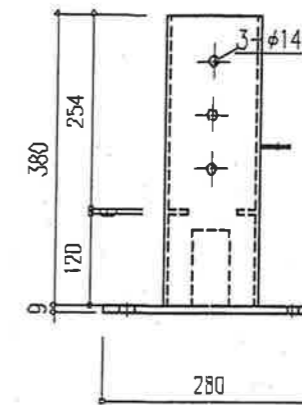
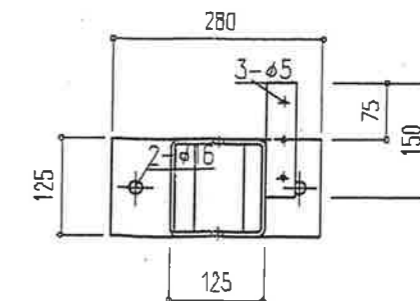

ベース金物

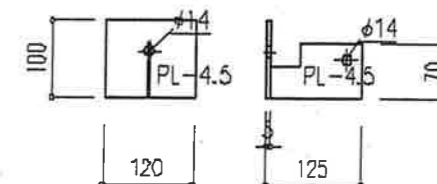

手摺受け金物

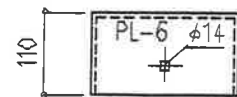
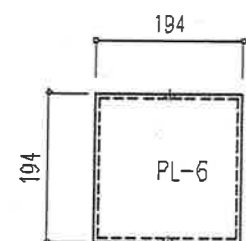

柱頭キャップ

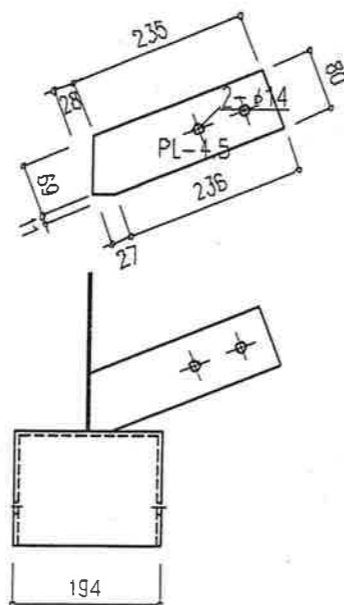
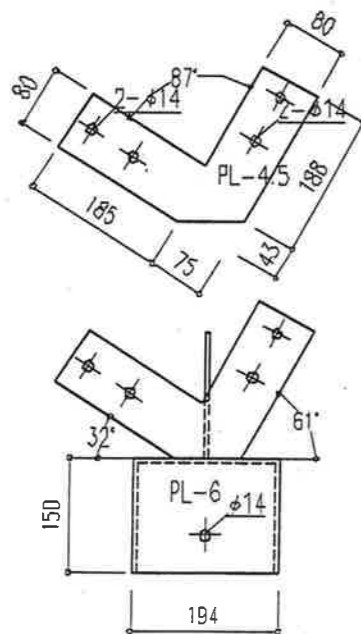

柱頭

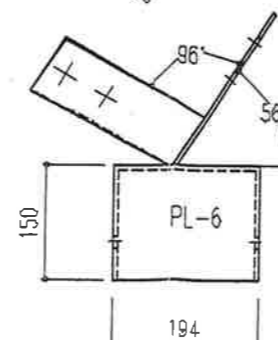
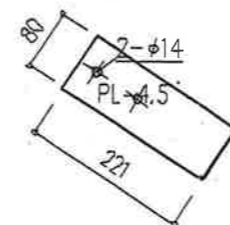

柱頭

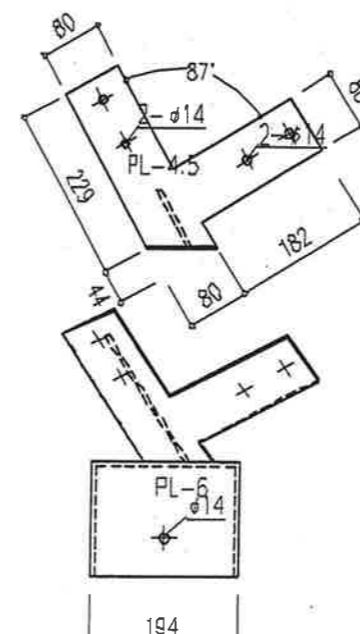

鋼材 SS400  
防錆処理方法 溶融亜鉛メッキ仕上

名称 四日市別山ニラカン2号公園ファミリー2工事